

Remote Switch ON/OFF  
Device with SMS!

2/4/8 Channel Relay Outputs

Schedule Switch ON/OFF  
Device

Auto Report Status by SMS!

# GSM/SMS/GPRS/3G/4G Remote Relay Switch

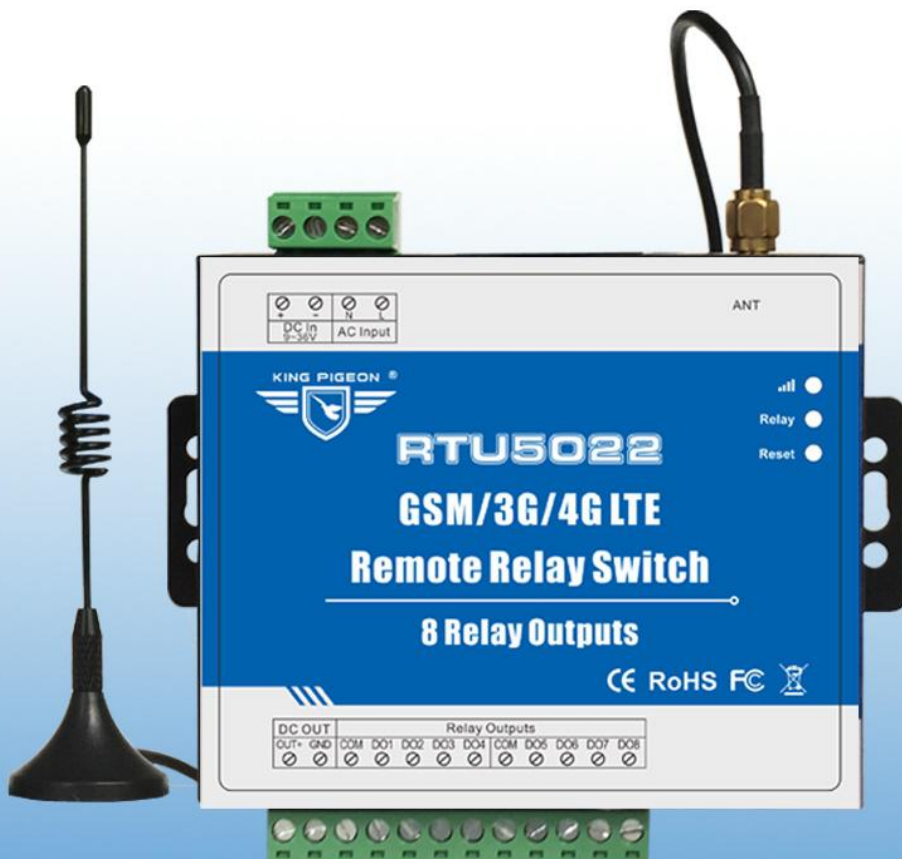

RTU5020/RTU5021/  
RTU5022

User Manual

Ver 1.3

Date Issued: 2018-01-24

King Pigeon Hi-Tech. Co., Ltd.

[www.GPRS-M2M.com](http://www.GPRS-M2M.com)



This handbook has been designed as a guide to the installation and operation of RTU5020,RTU5021,RTU5022 GSM SMS GPRS 3G 4G Remote Relay Switch.

Statements contained in the handbook are general guidelines only and in no way are designed to supersede the instructions contained with other products.

We recommend that the advice of a registered electrician be sought before any Installation work commences.

King Pigeon Hi-Tech.Co., Ltd, its employees and distributors, accept no liability for any loss or damage including consequential damage due to reliance on any material contained in this handbook.

King Pigeon Hi-Tech.Co., Ltd, its employees and distributors, accept no liability for GSM Network upgrading or SIMCard upgrading due to the technology specifications contained in this handbook.

## 【UPGRADE HISTORY】

DATE	VERSION	FIRMWARE VERSION	DESCRIPTION
2017.9.15	V1.2	V1.1	1.Support New Cloud Network App 2.Revise the Timer Command 3.Supplement Modbus TCP Protocol
2018-1-12	V1.3	V1.3	1.Change Modbus TCP protocol to Modbus RTU protocol ;Revise Command of setting protocol 2.Add Command of access Modbus RTU Protocol to Cloud Platform

## 【Gentle Reminder】

Please scan the QR code below or search in Apple store to download the APP for easy setting.



Normal SMS App (Remote Relay Switch)

## 【Model List】

Model	GSM/GPRS/3G/4G	Relay Output	Rated Voltage	Rated Voltage
RTU5020	Optional	2	9~36VDC	Optional: 110~220VAC@50Hz
RTU5021	Optional	4		
RTU5022	Optional	8		
Notice	1. Default version is GSM; 2. DIN 35mm Rail installation bracket is optional; 3. For 3G WCDMA and 4G LTE version, please tell our sales where you would like to use them.			

# Table of contents

1. Brief introduction.....	3
2.Safety Directions.....	3

<b>3. Standard Packing List</b> .....	3
<b>4. Mainly Features</b> .....	4
<b>5. Technical specifications</b> .....	4
<b>6. Physical Layout and Installation Diagram</b> .....	4
<b>7. Initialize/Reset the unit</b> .....	6
<b>8. Settings&amp;Operation</b> .....	7
<b>9. Data Communication Protocol</b> .....	10
<b>10. Warranty</b> .....	11

**1. Brief introduction**

The GSM SMS GPRS 3G 4G Remote Relay Switch embedded GSM/GPRS/3G/4G module and high performance MCU to provide a useful remote control solution. It special for real-time remotely switch on/off equipments through wireless cellular network.

It provides 2/4/8 Relay outputs for schedules automatically switch ON/OFF devices or remote by SMS or GPRS/3G/4G networks.

It has been designed as a cost effective, low power, easy use, and reliable controller. It can be used in the worldwide through the wireless cellular network, operation in anywhere, no distance limitation.

**Typically applications:**

Street light, pump station, Server room, Warehouse, Transformer stations, BTS room, agriculture, Supervision and monitoring alarm systems, etc.

**2.Safety Directions**



**Safe Startup**

Do not use the unit when using GSM/3G/4G equipment is prohibited or might bring disturbance or danger.



**Interference**

All wireless equipment might interfere network signals of the unit and influence its performance.

**3. Standard Packing List**

Remote Relay Switch X 1; Antenna X 1; AC/DC adaptor (12V1.5A) X1; User Manual (CD) X 1.

*Note: The package does not include any SIM card.*

**Optional:** 35mm Standard DIN rail fixed Bracket

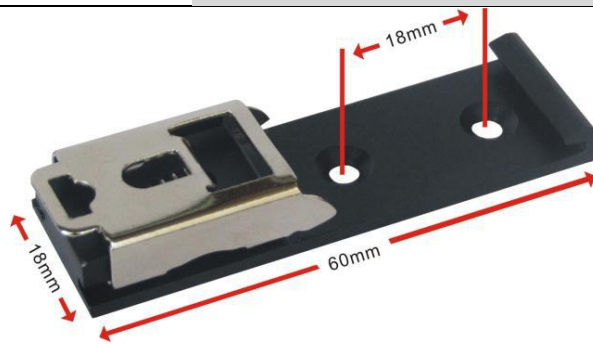

35mm DIN Rail Fixed Bracket

**4. Mainly Features**

- Can be operated from anywhere, no distance limitation;
- Quad band 850/900/1800/1900Mhz GSM GPRS Module inside;
- 3G UMTS/HSDPA/4G Modules are optional;
- 32 bit MCU, reliable performance with in-built watchdog;
- Support 2/4/8 relay outputs,7A@125VAC,5A@125VAC, 20A@14VDC;
- Supports 1 DNS or IP address as server, supports Modbus RTU, TCP/IP protocol over GPRS/3G/4G network;
- Automatically resend the data while communication failure, GPRS failure will alert by SMS text;
- Supports remotely restart the device, and configure it by SMS commands remotely;
- Up to 10 user's phone number to receive daily report SMS and relay status;
- Provides daily report, schedule upload, event upload by the GPRS/3G/4G to monitoring center or by SMS to the user mobile phone directly;
- Support Android/IOS APP, easily & friendly for use/config.
- Wall mount or 35mm standard DIN rail Design, convenient installation;
- Metallic cover, small size, exterior dimension is L105\*W88\*H30mm.



**5. Technical specifications**

Parameter item	Reference scope
<b>DC Power supply</b>	9~36VDC, recommend 12VDC1A, optional 110~220VAC @50Hz
<b>Power consumption</b>	12V input Max. 400mA/Average30mA, standby 20mA ;
<b>Cellular Frequency</b>	2G: 850/900/1800/1900Mhz 3G version Optional: (UMTS/HSDPA) W:900/2100@UMTS 900/1800@GSM; C:850/1900@UMTS 850/900/1800/1900@GSM; T:850/2100@UMTS 850/900/1800/1900@GSM; 4G LTE Version Optional
<b>SIM Card</b>	Supporting 3V SIM Card
<b>GSM/3G/4G Antenna</b>	50 Ω SMA Antenna interface
<b>Relay Outputs</b>	2 Relay Outputs 7A@125VAC 5A@125VAC 20A@14VDC
<b>Temperature range</b>	-40~+60 °C
<b>Humidity range</b>	Relative humidity 0~90% (condensation free)
<b>Backup Battery</b>	900mAH, last 8hours
<b>Exterior dimension</b>	L105mm*W88mm*H30mm
<b>Installation</b>	35mm standard DIN rail(Optional) Wall mount (Default)
<b>Net Weight</b>	500 g

**6. Physical Layout and Installation Diagram**

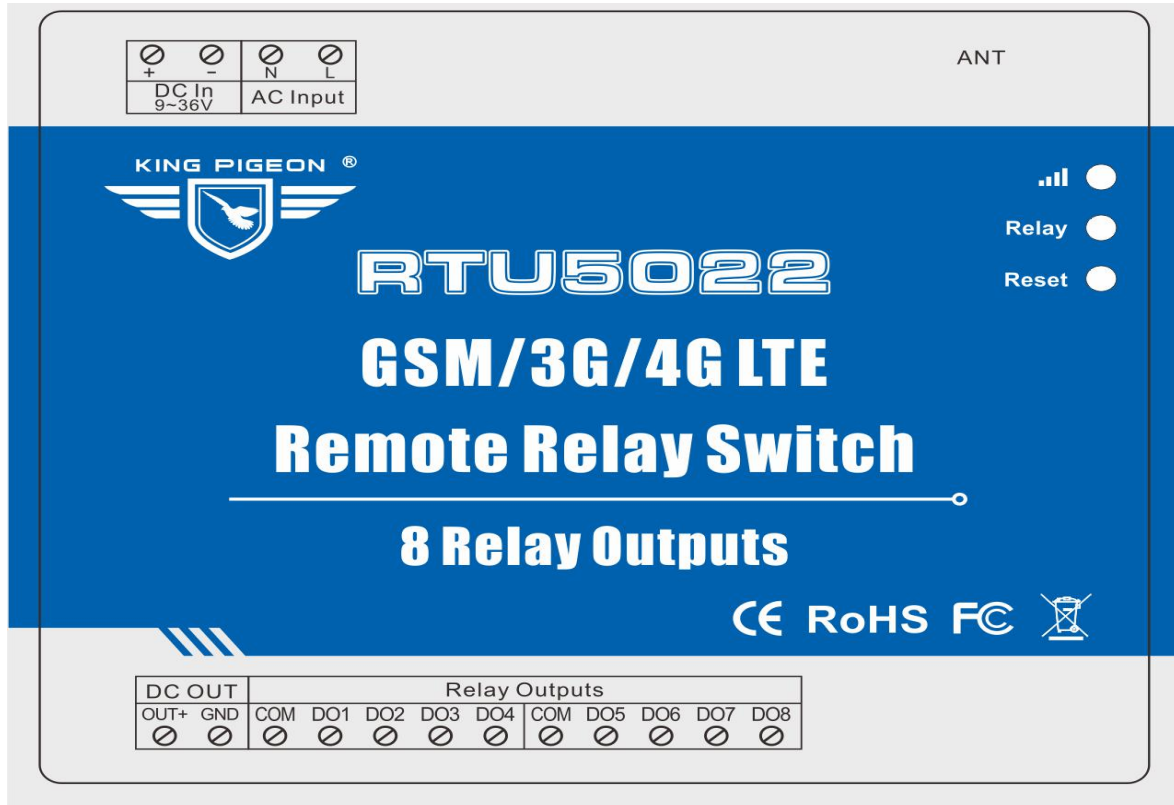
## 1) LED Indicator Instruction



LED Indicator Instruction	
	Cellular indicator, registering cellular Network flicks quickly, registered successful will 1 seconds flick once.
	Relay indicator, any one relay close, will turn on.
	Reset indicator, will turn on 5seconds while reset operation successful.

## 2) Interface Instruction

See below interface, please contact the correct wires.

Interface Instruction		
DC In 9~36V	+	DC9~36V positive input, 1.5A, for power on the Unit;
	-	DC9~36V negative input, 1.5A, for power on the Unit;
AC Input	N	Neutral wire, connect to 110~220VAC @50Hz alternating current, for power on the Unit;(Optional)
	L	Live wire, connect to 110~220VAC @50Hz alternating current, for power on the Unit; (Optional)
ANT	GSM/3G/4G antenna.	
DC OUT	OUT+	DC voltage output positive, the output voltage = DC Input voltage. Only when the device powered on by DC power, these ports will output DC voltage. If the device powered on by AC power, these ports will not output DC voltage.
	GND	DC voltage output negative input.
Relay Outputs	COM	Relay negative input.
	DO1	Relay 1 positive input.
	DO2~8	Relay 2~8 positive input.

The unit provides 2/4/8 relay outputs; it can be used for control different device according to requirements.

The connection diagram is below:

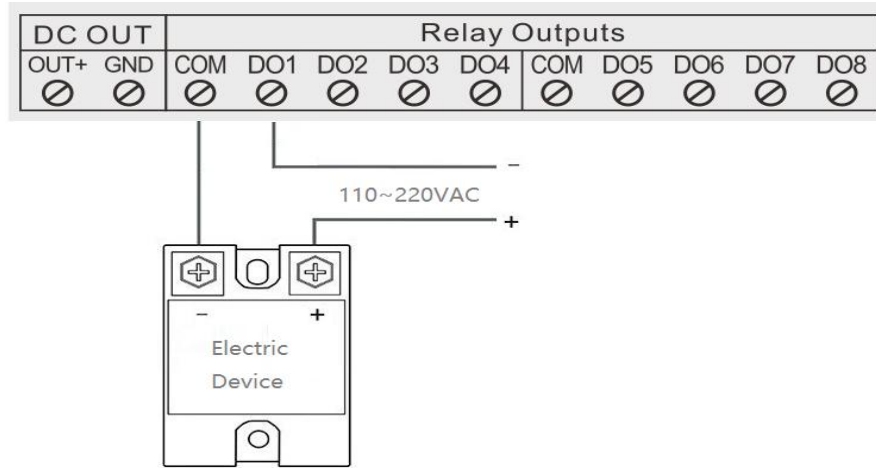

### 3) Insert SIMCard

At the backside of the panel, please use the tool to remove the screw, and you can see the below:

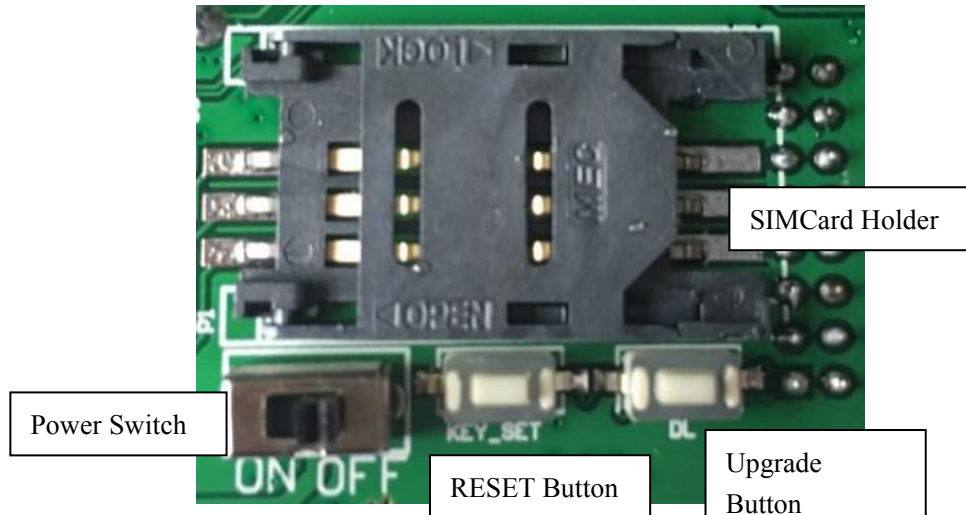

Slide the SIM card holder in the direction of "OPEN" (etched on the SIM card holder) then flip it open. Then insert the SIM card with its gold contacts facing down and its cut-off corner facing up into the SIM card slot. See below photo. Close the SIM card holder and then slide it in the opposite direction to lock it. See above photo.

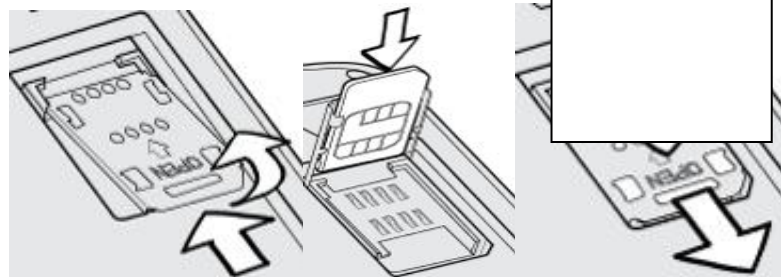

## 7. Initialize/Reset the unit

The Unit can be reset to factory default once mistake programmed. Please follow below steps to initialize it. After initialized, the parameters will set as factory default.

- 1) Switch off the Unit
- 2) Press the RESET button;
- 3) Switch the Power Switch to ON side to powered on the Unit, holding 5seconds, then loose the RESET Button.
- 4) Restart the unit then recovery to factory default settings, and will enter to work mode.



## 8. Settings&Operation

**\*\*\*Strongly Recommend using the APP to program it\*\*\***

### Notice:

1. The default Password is **1234**.
2. The unit cannot support PIN Code Protected SIMCard.
3. You can program the GSM unit with SMS commands using your phone.
4. Remember that commands must be **CAPITAL LETTERS**. It is PWD not pwd, CAP not Cap etc. Don't add spaces or any other character.
5. The **pwd** in the commands is means the password, when you use it, please in stand of it by the digital number; the capital letters **PWD** is the command letter, use PWD directly.
6. In some GSM operators they use different SMS parameter; the units can't return the SMS confirmation in some gsm operators, but it can performance the functions correctly. Also, you can try to add the country code before the number, see the below settings:

**For example:**

E.g.: the country code is **0086**, or **+86**.

The user cell phone number is **13600000000** and has been assigned as a SMS Alert number, the simcard number in the panel is **13512345678**.

When you setup the number as the authorized number, please setup as 0086136000000000 or +86136000000000. Not 136000000000.

7. If the password is correct but the command is incorrect, the RTU502x will return: **SMS Format Error, Please check Caps Lock in Command!** So please check the Command, or add the country code before the telephone number or check the input is in ENGLISH INPUT METHOD and CAPS LOCK. If password incorrect then will not any response SMS.
8. Once the Unit received the SMS Command, will return SMS to confirmation, if no SMS return, please check your command or resend again.
9. The SMS commands that you will certainly use in the GSM units are the following:

**\*\*SMS Commands For Program and Operation the RTU502x\*\***

### 1) Commands error return SMS

Event	Return SMS Content
Any incorrect Command	SMS Format Error, Please check Caps Lock in Command!

### 2) External DC Status

Event	Return SMS Content
External DC Power Goes OFF	External Power Goes OFF
External DC Power Goes ON	External Power Goes ON

### 3) Modify Password(4digits, Default is: 1234)

Command	Return SMS	Example
PWD+P+new password	[new password],This is the New Password, please remember it carefully.	<b>1234P4321</b> stands for change password from 1234 to 4321



## 4) Setup Device Time

If you want to use the timer function, then must setup the system time after power on. Otherwise, the unit will run it at mistake time. And when the backup battery out of voltage, then the time information will lose and should re-setup the time again.

Command		Return SMS	Example
Setup	PWD+DyymmddThhmm	xx(Y)xx(M)xx(D)xx(H)xx(M)	1234D170102T1234
Inquiry	PWD+D	xx(Y)xx(M)xx(D)xx(H)xx(M)	1234D

## 5) Inquiry Current Status SMS command

SMS Command	Return SMS Content
PWD+EE	Model: Version: IMEI: GSM Signal Value: External Power Goes OFF/ON DO1: Close/Open DO2: Close/Open -----

## 6) Setup 10 User Number, max 21 digits. ( Return 1~5 or 6~10 separately while setting.)

SMS Command		Return SMS Content
Setup	PWD + A + series number + T + tel number  Notice: Series number = 1~10 e.g.: 1234A3T008613570810254 to setup 008613570810254 as the 3 <sup>rd</sup> number.	Tel1: --- Tel2: --- Tel3: 008613570810254 Tel4: --- Tel5: ---
Inquiry	PWD + A	Return all numbers
Delete	PWD + A + series number	Return 1~5 or 6~10 numbers.

## 7) Setup Daily Report Time

SMS Command		Return SMS Content
Setup	PWD + DR + series number + T + xx + yy (Notice: series number = 1~10, xx = 00~23, stands for hour, yy = 00~59, stands for minutes. )	Daily SMS Report at: 1. xx:xx 2. .... .....
Inquiry	PWD + DR	Daily SMS Report at: xx:xx
Delete	PWD + DRDEL + series number	Daily SMS Report at: xx:xx

## 8) SMS Control Relay Output

SMS Command		Return SMS Content
Set DO Name	PWD + DO + channel number + T + DO Name	DOx:xxxx
Inquiry DO Name	PWD + DO + channel number <nn>	DOx:xxxx
Delete DO Name	PWD + DO + channel number <nn> + DEL	DOx:
Switch ON(Close)	PWD + DOC + channel number <nn>	DOx: ON DOy:ON
Switch OFF(Open)	PWD + DOO + channel number <nn>	DOx: OFF DOy:OFF





Inquiry all DO Current Status	PWD +DOE	DO1: ON/OFF DO2:ON/OFF
Set Pulse Output time	PWD +DOP+ channel number<nn> +T+xxxx ( <b>Notice:</b> xxxx=0~9999seconds, =0 stands for always close)	DOx Pulse Output Time:xxxx(S)
Inquiry pulse output time	PWD +DOT+ channel number<nn>	DOx Pulse Output Time:xxxx(S)
Pulse Output	PWD +DOP+ channel number<nn>	

**9) Setup Timer**(Total can setup 10 timer, every week to perform the preset actions, in timer action, the relay exchange status will not alert SMS to users)

SMS Command		Return SMS Content
Set Timer	Relay Close Timer: PWD+T+serial number(1~10)+Wx+Hhhmm+DOC + channel number Relay Open Timer: PWD+T+serial number(1~10)+Wx+Hhhmm+ DOO+ channel number Notice: x =0~7, 0 stands for everyday,1~7stands for Monday ~ Sunday; hh= 00~23, 2 digits, stands for hour; mm=00~59, 2 digits, stands for minute; Tips: Relay close time is according to Pulse output time. Eg: Relay 1 pulse output time is 60s,then timer relay 1 close 60 seconds.	DOx: Weekly x hh:mm close  DOx: Weekly x: hh:mm open.
Inquiry	PWD+T+serial number<nnnnnnnnnn>	1. 2. ...
Delete Timer	PWD+T+Serial number+DEL	

**10) Reboot**

SMS Command		Return SMS Content
Reboot	PWD+Reboot	Restart the device

**11) Setup the GPRS Parameter (APN/USER NAME/PASSWORD)**

SMS Command		Return SMS Content
Set	PWD+AP+apn+#+username+#+userpassword ( <b>Notice:</b> apn=access point name)	APN: User Name: Password:
Inquiry	PWD+AP	
Delete	PWD+APDEL	

**12) Setup the Server Parameter**

SMS Command		Return SMS Content
Set Server IP	PWD+IP+ IP address+*+Server port	Server: Port:
Inquiry	PWD+IP	Server:



		Port:
Delete	PWD+IPDEL	Server: Port:

### 13) Setup the GPRS Communication Protocol

SMS Command		Return SMS Content
Choose Modbus RTU protocol	PWD+MRTU	Modbus RTU
Choose Definition Protocol	PWD+DTCP	Definition Protocol
Tips: If choose Modbus RTU protocol, the Server will revert to the setting that domain name is modbus.dtuip.com, port is 6651. If choose Definition Protocol, the Server will revert to the setting that domain name is www.rtu-m2m.com, port is 8001.		

### 14) Wakeup GPRS Online

SMS Command	Return SMS Content
password+GPRSONline	GPRS Online
Password+GPRSoFF	GPRS OFF

### 15) Setup Device ID Number

SMS Command		Return SMS Content
Setup	PWD + IDxxxxx xxxxx=1~65535, Default is 1. Tips: If choose Modbus RTU protocol, xxxxx=1~255	ID:XXXXXX
Inquiry	PWD +IDE	ID:XXXXXX

### 16) Setup the Login Message (used for Modbus RTU protocol)

SMS Command		Return SMS Content
Set	PWD+RTP+Login Message content Max:50 Characters	Registration package:....
Inquiry	PWD+RTE	

### 17) Setup the Heartbeat (used for Modbus RTU protocol)

SMS Command		Return SMS Content
Set	PWD+HET+Heartbeat content Max:20 Characters, default is ACK	Heartbeat package content:ACK
Inquiry	PWD+HEE	

### 18) Setup the Heartbeat Interval (used for Modbus RTU protocol)

SMS Command		Return SMS Content
Set	PWD+HT+xxx xxx=0~9999, stands for second,=0 stands for not upload, default is 60 seconds.	Heart Pack Period:xxx second
Inquiry	PWD+HTE	

## 9. Data Communication Protocol



The RTU502x support GPRS/3G/4G data transfer to cloud server, support Modbus RTU protocol, TCP/IP protocol and GPRS definition protocol. For GPRS Communication protocol, please refer to <RTU502x GPRS/3G/4G Protocol Instruction>.

Modbus RTU Address: Support the function code 01, 05, 15

DO1	DO2	DO3	DO4	DO5	DO6	DO7	DO8
0X00	0X01	0X02	0X03	0X04	0X05	0X06	0X07

### 10. Warranty

- 1) This system is warranted to be free of defects in material and workmanship for one year.
- 2) This warranty does not extend to any defect, malfunction or failure caused by abuse or misuse by the Operating Instructions. In no event shall the manufacturer be liable for any alarm system altered by purchasers.

Any questions please help to contact us feel free.

[Http://www.GPRS-M2M.com](http://www.GPRS-M2M.com)

The End!